

Varenummer: 204380M24200D3V

Beskrivelse: E+G Justerfod
GN 43-80-M24-200-D3-V

Note: V Uden møtrik, udvendig sekskant i toppen, spændeflade i bunden

Mål

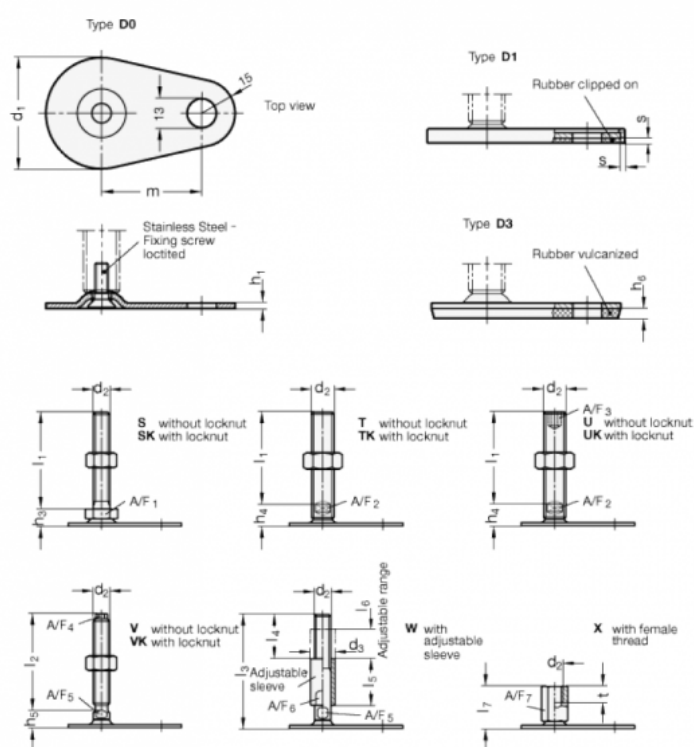

A/F4 = 17	m = 70
A/F5 = 20	s =
d1 = 80	
d2 = M24	
h1 = 3	
h5 = 15	
h6 = 5	
l2 = 200	